

DATE

PROJECT NOTES

The Celeste single-SDCM light engine is designed for precision and delivers flawless light quality. Unmatched performance for CRI, R9, Fidelity, & Gamut with a 12-year warranty.

- Single step MacAdam ellipse for superior color consistency
- Unmatched performance for CRI, R9, Fidelity, & Gamut
- Consistent tight pitch (LED density) at all output levels
- Field of Factory Assembly
- Gold plated solder points extend lifespan and thermal performance
- Title 24 - JA8 Compliant
- 12 year warranty

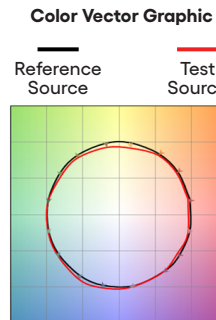

Lucetta Lighting	Voltage	Model	Lumens	CCT	Run Length (ft.)	Channel	Driver
VIP	-						
	24	CEL	150	2400K 3000K	W Run Length (ft.)	SQ20	ELV SWX
			300	2700K 3500K		RC20	MAG ND
			500			16mm	0-10 Lutron PoE

Example: VIP-24CEL150-20-W23-ELV

General Specifications	
SDCM Steps ³	Single Step MacAdam Ellipse - True Single Binning
Voltage	24VDC
Cut Points	1.32 in.
LED Chips	72/ft.
Dimmable	Yes
Field Cuttable	Yes
Dimensions	0.47 x 0.1 in. (W x H)
Environment	Outdoor / Wet Location (IP65)
Certification	UL Listed 2108, RoHS, Title 24 - JA8 ⁵
Warranty	12 Years
Gold Plated PCB	Yes

VIP-24CEL300-XX-W				
	2400K	2700K	3000K	3500K
Delivered Lumens ¹	266 Lm/ft.	286 Lm/ft.	303 Lm/ft.	311 Lm/ft.
Luminous Efficacy ²	81 Lm/W.	87 Lm/W.	92 Lm/W.	94 Lm/W.
CRI	97	97.5	97.4	98.2
R9	96.3	98.9	98.7	99.6
RF Skin	99	99	98	97
Gamut	103	103	103	102
Fidelity	95	95	95	96
Wattage / Max Run ⁴	3.3W/ft., 47 foot maximum run length			

VIP-24CEL150-XX-W				
	2400K	2700K	3000K	3500K
Delivered Lumens ¹	156 Lm/ft.	158 Lm/ft.	149 Lm/ft.	155 Lm/ft.
Luminous Efficacy ²	86.5 Lm/W.	88 Lm/W.	83 Lm/W.	86 Lm/W.
CRI	96.7	97.5	97.4	98.2
R9	98	98.9	98.7	99.6
RF Skin	99	99	98	97
Gamut	103	103	103	102
Fidelity	95	95	95	96
Wattage / Max Run ⁴	1.8W/ft., 55 foot maximum run length			

VIP-24CEL500-XX-W				
	2400K	2700K	3000K	3500K
Delivered Lumens ¹	425 Lm/ft.	456 Lm/ft.	487 Lm/ft.	505 Lm/ft.
Luminous Efficacy ²	79 Lm/W.	85 Lm/W.	90 Lm/W.	94 Lm/W.
CRI	97	97.5	97.4	98.2
R9	96.3	98.9	98.7	99.6
RF Skin	99	99	98	97
Gamut	103	103	103	102
Fidelity	95	95	95	96
Wattage / Max Run ⁴	5.4W/ft., 31 foot maximum run length			

Recommended Drivers

(For use with drivers not listed here, please call Customer Service at 877-817.6028)

SKU	WATTAGE	LENGTH	WIDTH	HEIGHT
OMNIDRIVE® X Versatile driver for most high-performance dimming applications. 0-10V & ELV. Dims to 5% or 1%.				
DI-ODX-24V30W-J	30W	11.25 in.	3.75 in.	1.80 in.
DI-ODX-24V60W-J	60W	13.5 in.	4.50 in.	2.25 in.
DI-ODX-24V96W-J	96W	13.5 in.	4.50 in.	2.25 in.
DI-ODX-24V120W-JBOX	120W	15 in.	3.10 in.	2.30 in.
DI-ODX-24V200W-JBOX	200W	16 in.	3.40 in.	2.40 in.
JUSTIN Inc. MAGNETIC DRIVERS Optimal dim to dark 24V Dimmable MLV Drivers. Dims to dark.				
481-24DCR	120VAC	11.25 in.	3.37 in.	3.25 in.
482-24DCR-240	240VAC	11.25 in.	3.37 in.	3.25 in.
483-24DCR-277	277VAC	11.25 in.	3.37 in.	3.25 in.
961-24DCR	120VAC	11.25 in.	3.37 in.	3.25 in.
962-24DCR-240	240VAC	11.25 in.	3.37 in.	3.25 in.
963-24DCR-277	277VAC	11.25 in.	3.37 in.	3.25 in.
SWITCHEX In wall, Dimmer/Driver in one. Dims to 5%				
DI-24V-SE-40W	40W	Fits in standard switch box		
DI-24V-SE-60W	60W	Fits in standard switch box		
DI-24V-SE-100W	100W	Fits in standard switch box		
VLM SERIES DRIVER. Non-dimming and low voltage dimming/control.				
VLM60-24-LPM	60W	8.19 in.	2.94 in.	1.31 in.
VLM100-24-LPM	100W	8.19 in.	2.94 in.	1.31 in.
LUTRON Hi-lume 1% LED DIMMABLE DRIVER				
DI-DM-24V40W-L3D	40W	4.89 in.	4.00 in.	2.62 in.
DI-DM-24V40W-LTE	40W	4.89 in.	4.00 in.	2.62 in.
LUTRON Hi-lume Premier 0.1% LED DIMMABLE DRIVER				
DI-DM-24V96W-L3D	96W	5.50 in.	2.20 in.	10.50 in.
PoE 24V constant voltage platform, ready for Power over Ethernet (Inquire)				



Mechanical Diagrams

Tape Light

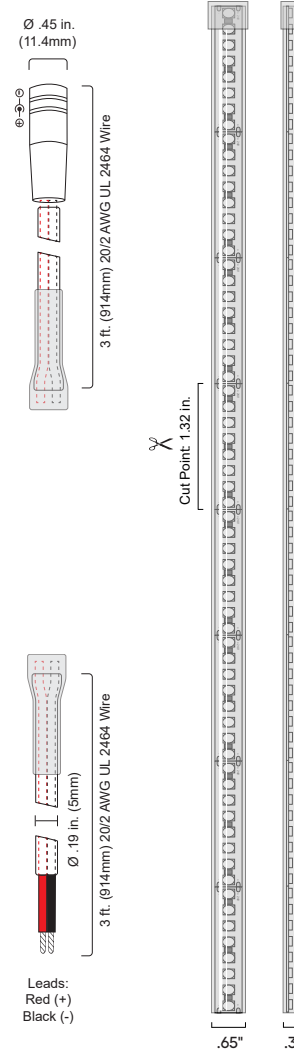

End Caps

DI-WL-12MM-EC-5

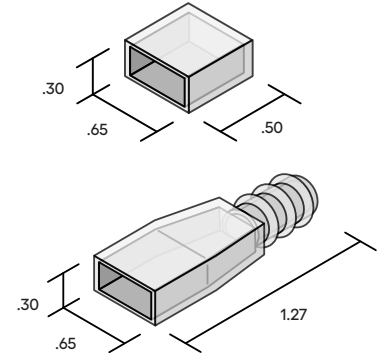

Mounting Clips

DI-WLMC-12MM

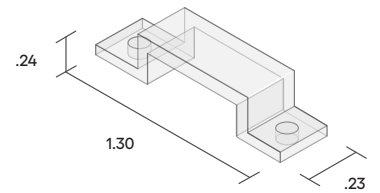

Channels

Channels are compatible with Wet Location tape light in environments exposed to water (including splash and spray). Do not expose to direct sunlight (UV). Do not submerge.

Mount Wet Location tape light into channels using an epoxy, silicone adhesive, or 3M® adhesive. Use adhesive that is suitable for the installation environment, including ambient temperature and humidity, and that is safe for use on aluminum and silicone (e.g. Liquid Nails®, Loctite®). Secure channels with mounting clips or with screws appropriate for the surface material; do not use 3M® adhesive to mount channels in wet environments.

20mm Square Corner Channel (SQ20)

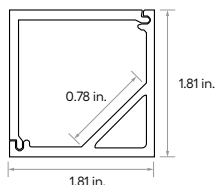

20mm Square Corner Channel

DI-CPCHB-SQ20-48	<ul style="list-style-type: none"> • 48 in. channel & frosted cover • End caps: 1x open, 1x closed • Mounting hardware
DI-CPCHB-SQ20-96	<ul style="list-style-type: none"> • 96 in. channel & frosted cover • End caps: 1x open, 1x closed • Mounting hardware

20mm Rounded Corner Channel (RC20)

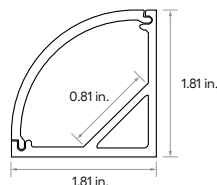

20mm Rounded Corner Channel

DI-CPCHB-RC20-48	<ul style="list-style-type: none"> • 48 in. channel & frosted cover • End-caps: 1x open, 1x closed • Mounting hardware
DI-CPCHB-RC20-96	<ul style="list-style-type: none"> • 96 in. channel & frosted cover • End-caps: 1x open, 1x closed • Mounting hardware

16mm Channel (16mm)

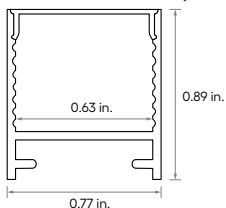

16mm Channel

DI-SO-CPCHB-BLOCK-48	<ul style="list-style-type: none"> • 48 in. channel & opal cover • End caps: 1x open, 1x closed • 2x mounting clip
----------------------	---

Compliance & Regulatory Approvals

- Meets the following certifications when installed with compatible UL Listed tape light:
 - UL Listed 2108 Flexible Lighting Systems. Certified for United States and Canada. File # E506975.
 - Approved for storage areas of clothes closets per NEC 410.16.A.1 and 410.16.C.5

Safety / Warnings / Disclosures

1. Install in accordance with national and local electrical code regulations.
2. This product is intended to be installed and serviced by a qualified, licensed electrician.
3. Only install with a listed Class 2 DC Constant Voltage LED Driver.
4. Not for use in or on walls of pools, fountains, or other partially or fully submersed locations.
5. Do not modify or disassemble product beyond instructions or this warranty will be void.
6. Actual color may vary from what is pictured above and on other print materials due to the limitations of photographic processes.
7. We reserve the right to modify and improve the design of our fixtures without prior notice. We cannot guarantee to match existing installed fixtures for subsequent orders or replacements in regards to product appearance, CCT, or lumen output.

Limited Warranty

- 12 Years

This warranty does not include the additional accessories referenced in this specification sheet. Complete warranty details for fixtures and additional accessories are available at <https://lucettalighting.com/limited-warranty/> within the Policies section. For warranty related questions please contact product support.

Consumer's Acknowledgment

Elemental LED, Inc. stands behind its products when they are used properly and according to our specifications. By purchasing our products, the purchaser agrees and acknowledges that lighting design, configuration and installation is a complex process, wherein seemingly minor factors or changes in layout and infield adjustments can have a significant impact on an entire system. Choosing the correct components is essential. Elemental LED is able to work with the original purchaser to make an appropriate product selection to the extent of the limited information that the customer can provide, but it is virtually impossible for Elemental LED to design a system that foresees every unknown factor. For this reason, this Warranty does not cover problems caused by improper design, configuration or installation issues. Any statement from a Elemental LED employee or agent regarding a customer's bill of goods and/or purchase order is NOT an acknowledgment that the products purchased are designed and configured correctly. The purchase agrees and acknowledges that it is the customer's responsibility to adhere strictly to all information contained in the Product Specification Sheets.

There is often more than one way to design, configure and layout an LED lighting application properly to achieve the same lighting effect. Elemental LED strongly recommends that licensed professionals be used in the design and installation of lighting systems that include Elemental LED products. The specifications include important information that a designer and installer should carefully review and strictly follow. Qualified designers and certified and/or licensed installers, with access to the final installation environment, customer goals, and Elemental LED product specifications can make the requisite decisions appropriate for a successful finished lighting application.